

Opera 180x180

PREDINSTALACIJA
PREINSTALLATION
PREINSTALLATION
VORINSTALLATION

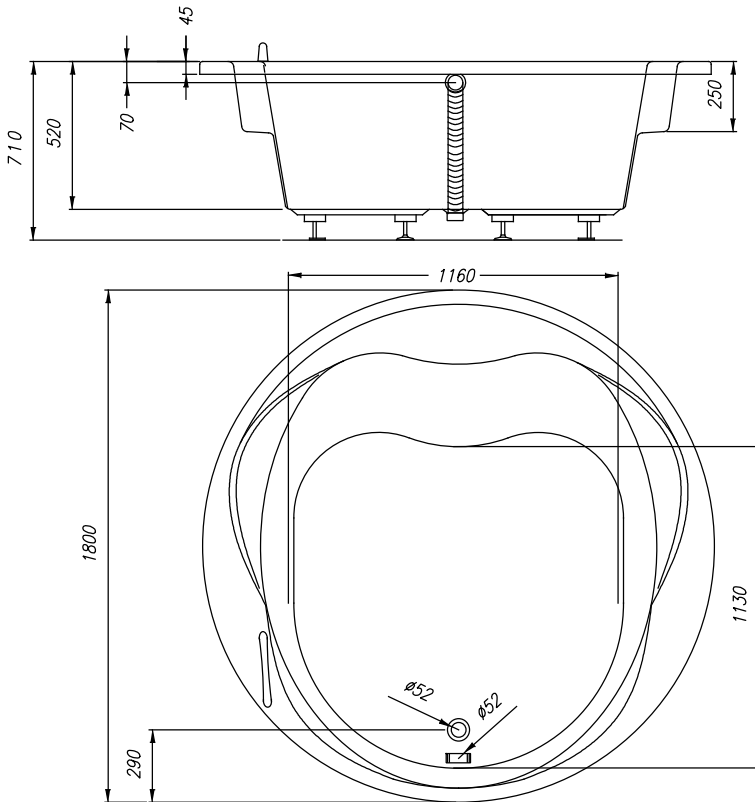
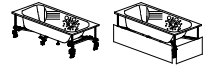

570 L

VOLUMEN
VOLUMEN
VOLUME
VOLUMEN

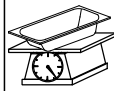

74 kg

TEŽA
TEŽINA
WEIGHT
GEWICHT

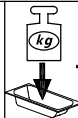

900 kg

MAX. OBREMENITEV
MAX. OBTEREČENJE
MAX. LOAD
MAX. BELASTUNG

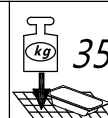

350 kg/m²

OBREMENITEV TAL
OBTEREČENJE PODA
FLOOR LOAD
BODENBELASTUNG

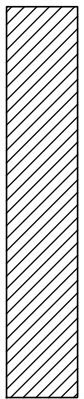

- Prostor za električni vodnik 3x2,5 mm², dolžine pribl. 1 m
- Mjesto za električni vodnik 3x2,5 mm², dužine cca. 1 m
- Spot for electrical cable 3x2,5 mm², length approx. 1 m
- Platz Stromkabel 3x2,5 mm², Länge ungefähr 1 m
- Prostor za električni vodnik 1x6 mm² za ozemljitev, dolžine pribl. 1,5 m
- Mjesto za električni vodnik 1x6 mm² za ozemljenje, dužine cca. 1,5 m
- Spot for electrical cable 1x6 mm² for earthing, length approx. 1.5 m
- Platz Stromkabel 1x6 mm² für Erdung, Länge ungefähr 1,5 m
- Priklop tople in hladne vode 1/2", min 0,2 Mpa, max 0,4 Mpa
- Priključak tople i hladne vode 1/2", min 0,2 Mpa, max 0,4 Mpa
- Connection of hot and cold water 1/2", min 0,2Mpa, max 0,4Mpa
- Anschluss Warm- und Kaltwasser 1/2", min 0,2 Mpa, max 0,4 Mpa
- Prostor za odtok Ø 50 mm
- Mjesto za odtok Ø 50 mm
- Drain spot Ø 50mm
- Abflussplatz Ø 50 mm



- Opcija - obloga
- Opcija - obloga
- Option - panel
- Möglichkeit - Schürze

priporočilo za vgradnjo
preporuka za ugradnju
installation recommendation
Einbauempfehlung

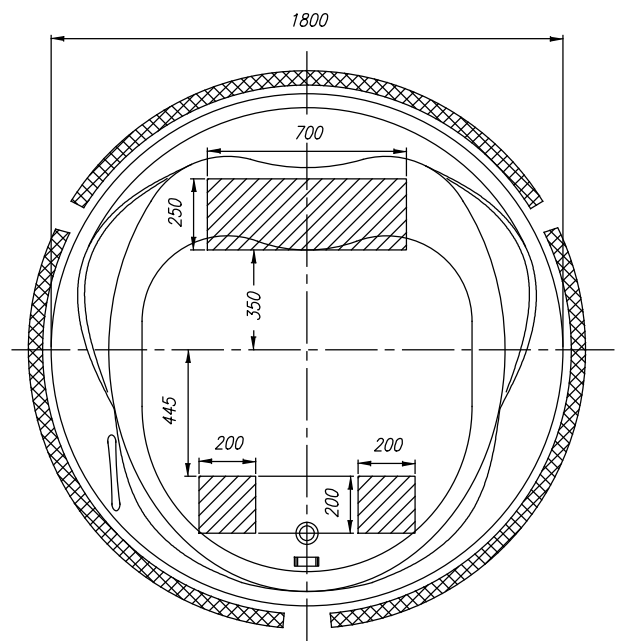

Priporočena prelivna garnitura
Preporuka prelivne garniture
Recommended overflow set
Vorgeschlagene Überlaufgarnitur

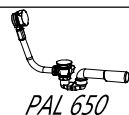

PAL 650

Kopalna kad z oblogo - navodilo za vgradnjo
Kada s oblogom - upute za ugradnju
Bathtub with panel - installation instructions
Badewanne mit Schürze - Einbauanleitung



Nr. MK 01

kopalna kad brez oblog - navodilo za vgradnjo
Kada bez obloge - upute za ugradnju
Bathtub without panel - installation instructions
Badewanne ohne Schürze - Einbauanleitung

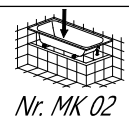

Nr. MK 02

Opcija podnožja za kadi z oblogo
Varianta postolja za kade sa oblogom
Option of the bathtub base with panel
Möglichkeit des Sockels für die Badewannen mit Schürze

sestavljeno
sastavljeno
pre-assembled
vormontiert

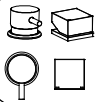

- MEŠALNI VENTIL TOPLA/HLADNA
- VENTIL ZA MIEŠANJE TOPLO/HLADNO
- MIXING VALVE HOT/COLD
- MISCHVENTIL WARM/KALT



- PREKLOPNIK ROČNA PRHA/IZLIV
- PREKIDAČ ZA RUČNI TUŠ/IZLJEV
- HAND SHOWER/SPOUT SELECTOR SWITCH
- SCHALTER FÜR HANDBRAUSE/AUSLAUF

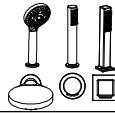

- ROČNA PRHA
- RUČNI TUŠ
- HAND SHOWER
- HANDBRAUSE

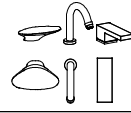

- IZLIV
- IZLJEVNIK
- SPOUT
- AUSLAUF



- IZLIV NA PRELIVNI GARNITURI
- IZLJEV NA PRELJEVNOM SETU
- SPOUT ON THE OVERFLOW SET
- AUSLAUF AN DER ÜBERLAUFGARNITUR

- OPCIJA ENOROČNA ARMATURA WATERFALL
- OPCIJA JEDNORUČNA ARMATURA WATERFALL
- MÖGLICHKEIT EINWEG-ARMATUR WATERFALL

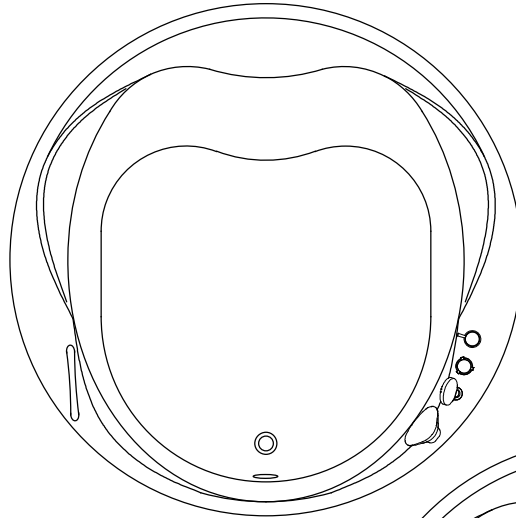
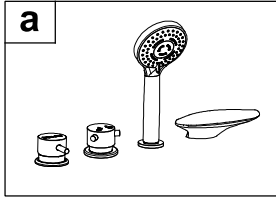

- OPCIJA ENOROČNA ARMATURA GEYSER
- OPCIJA JEDNORUČNA ARMATURA GEYSER
- OPTION ONE HAND FITTING GEYSER
- MÖGLICHKEIT EINWEG-ARMATUR GEYSER

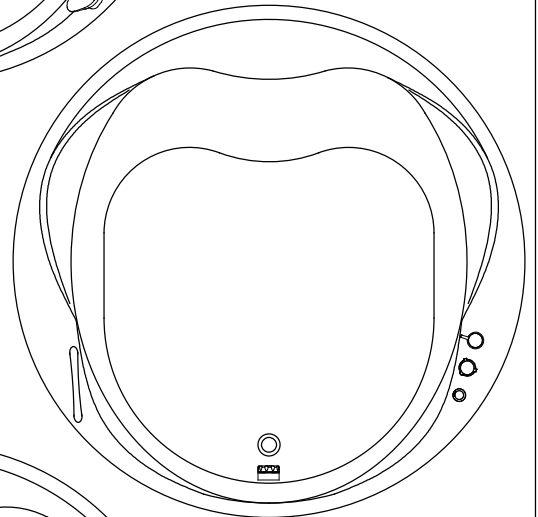
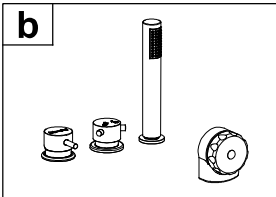

- OPCIJA ENOROČNA ARMATURA RAINDROP
- OPCIJA JEDNORUČNA ARMATURA RAINDROP
- OPTION ONE HAND FITTING RAINDROP
- MÖGLICHKEIT EINWEG-ARMATUR RAINDROP

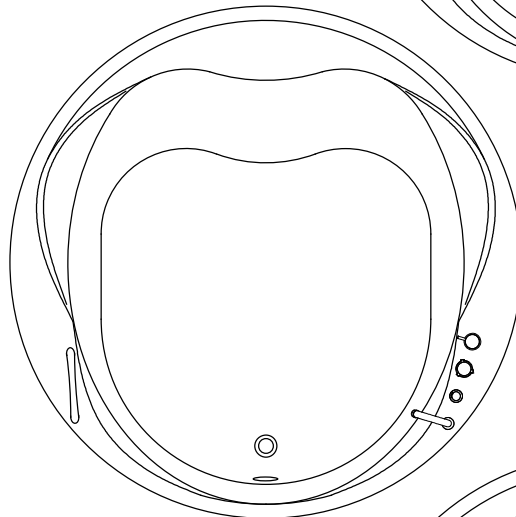
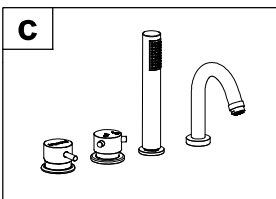

- OPCIJA ENOROČNA ARMATURA STREAM (CHR / BLACK)
- OPCIJA JEDNORUČNA ARMATURA STREAM (CHR / BLACK)
- OPTION ONE HAND FITTING STREAM (CHR / BLACK)
- MÖGLICHKEIT EINWEG-ARMATUR STREAM (CHR / BLACK)

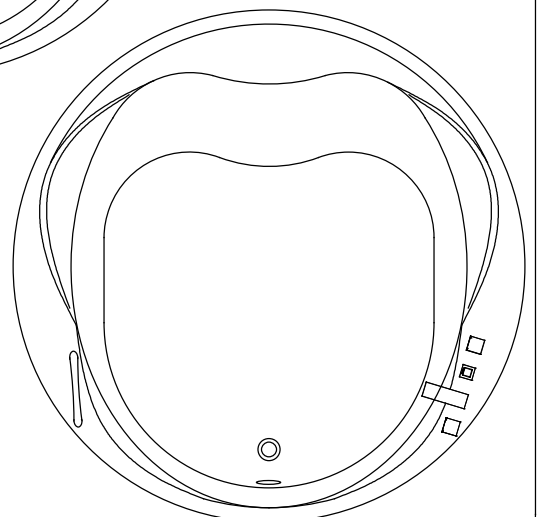
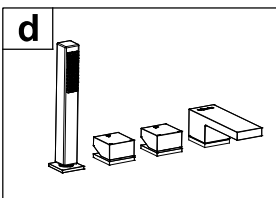

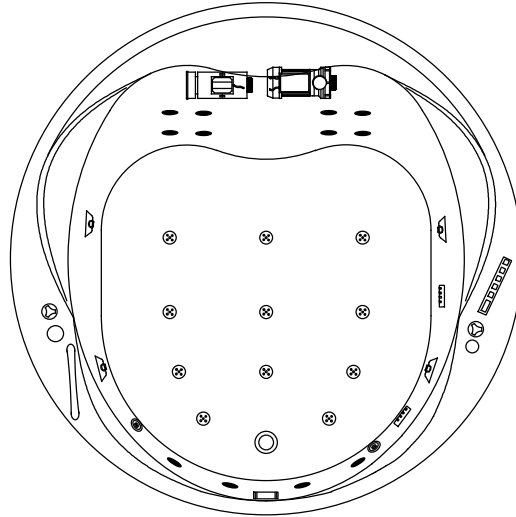
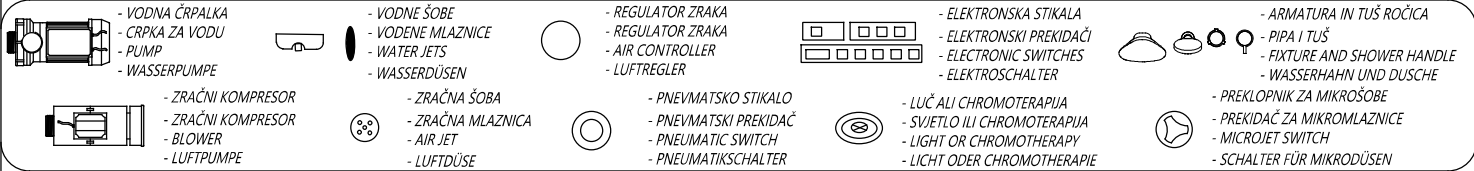

TEŽA
118 kg
TEŽINA
WEIGHT
GEWICHT

VITAL MASAŽNI SISTEM

- VODNA ČRPALKA P=1250W
- ZRAČNI KOMPRESOR P=800W
- GRELEC P=1500W
- ELEKTRONSKO STIKALO
- 2 REGULATORJA ZRAKA
- 4 SUPER VODNE ŠOBE
- 11 ZRAČNIH ŠOB
- OZON ZA DEZINFEKCIJO
- CHROMOTERAPIJA
- 2x4 MIKROŠOBE ZA HRBET
- 4 MIKROŠOBE ZA NOGE

VITAL MASAŽNI SISTEM

- CRPKA ZA VODU P=1250W
- ZRAČNI KOMPRESOR P=800W
- GRIJAC P=1500W
- ELEKTRONSKI PREKIDAČ
- 2 REGULATORA ZRAKA
- 4 SUPER VODNE MLAZNICE
- 11 ZRAČNIH MLAZNICA
- OZON ZA DEZINFEKCIJU
- CHROMOTERAPIJA
- 2x4 MIKROMLAZNICA ZA LEDA
- 4 MIKROMLAZNICE ZA NOGE

VITAL MASSAGE SYSTEM

- PUMP P=1250W
- BLOWER P=800W
- HEATER P=1500W
- ELECTRONIC SWITCH
- 2 AIR CONTROLLERS
- 4 SUPER WATER JETS
- 11 AIR JETS
- OZONE FOR DISINFECTION
- CHROMOTHERAPY
- 2x4 MICROJETS FOR BACK
- 4 MICROJETS FOR FEET

VITAL MESSAGESYSTEM

- WASSERPUMPE P = 1250 W
- LUFTPUMPE P = 800 W
- HEIZKÖRPER P = 1500 W
- ELEKTROSCHALTER
- 2 LUFTREGLER
- 4 SUPER WASSERDÜSEN
- 11 LUFTDÜSEN
- OZON FÜR DESINFEKTION
- CHROMOTHERAPIE
- 2x4 MIKRODÜSEN FÜR RÜCKEN
- 4 MIKRODÜSEN FÜR FÜSSE

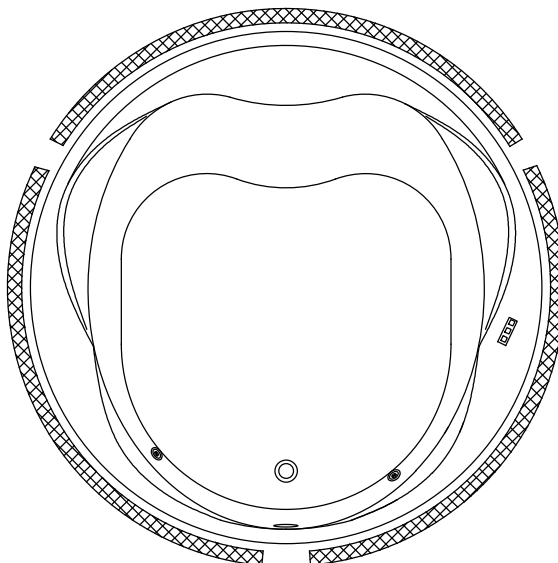

OPCIJE

- OPCIJA CHROMOTERAPIJA



OPCIJE

- OPCIJA CHROMOTERAPIJA

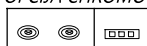

OPTIONS

- OPTION CHROMOTHERAPY

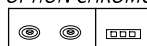

MÖGLICHKEITEN

- MÖGLICHKEIT CHROMOTHERAPIE

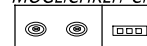

- POLOŽAJ OBLÓG NA KOPALNI KADI



- POZICIJA OBLÓGE NA KADI

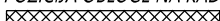

- PANEL POSITIONS ON THE BATH



- POSITION DER SHÜRZE FÜR BADEWANNE

